

Advanced Wind/Solar Hybrid Controller

Model: WWS03A-12

WWS03A-24

Version 1.0





1. Thank you very much for purchasing our controller, please read the use manual carefully before installing and using the products and keep it with due care.
2. The installation must be done by experienced technical personnel in the installation operation, the installation process must be strictly in accordance with the use manual to ensure that the product can work properly.
3. This product should be avoided long-term exposure to corrosive gas and moisture environment.
4. Do not put this product in wet, rain, exposure, severe dust, shock, corrosion and strong electromagnetic interference environment.
5. Do not open the shell to repair this product by yourself.

Catalogue

1. General Description.....	1
2. Model Description.....	2
3. Features.....	2
4. Operational Regulations.....	3
5. LCD Operation and Display Instructions.....	4
5.1 Description of the Key.....	4
5.2 Displaying Contents Description.....	5
5.3 Browsing Parameters and Output Modes Description.....	6
5.4 Setting Parameters and Output Modes Description.....	7
5.5 Manual Brake Setting.....	7
6. Parameters.....	8
7. Abnormal Phenomenon and Treatment.....	9
8. Warranty and After Sales Service.....	9

1. General Description

The advanced wind/solar hybrid controller is specially designed for high-end small-scale wind/solar hybrid system and especially suitable for wind/solar hybrid street light system and wind/solar hybrid monitoring system.

The controller adopts PWM to control wind turbine and solar cell charge the battery with voltage limiting and current limiting, namely, the controller will charge battery with current limiting when battery power is low and charge battery with voltage limiting when battery power is high. When the total charge current of wind turbine and solar cell is lower than current limiting point, the controller will charge the battery with the whole power generated by wind turbine and solar cell. When the total charge current of wind turbine and solar cell is more than current limiting point, the controller will charge the battery with the current limiting point, the excess energy will be unloaded by PWM. When battery voltage is lower than voltage limiting point, the controller will charge the battery with the whole power generated by wind turbine and solar cell. When battery voltage is up to voltage limiting point, the controller will charge battery with voltage limiting point and the excess power will be unloaded by PWM.

The controller has two DC output specially designed for street light system. Each DC output has Three modes of controlling output, including: (1)constant on, (2)light-control on and light-control off, (3)light control on and time control off, The three modes can be setted by LCD key, Light control on and light control off is achieved by detecting the voltage of solar panels which can be setted through LCD key and serial communication. In addition, the time of time control off can also be setted through LCD key and serial communication.

The controller adopts LCD module especially designed for wind/solar hybrid system. The LCD can display battery voltage, wind turbine voltage, photoelectric voltage, wind power, PV power, wind turbine current, PV current, controlling output mode of the first load, the time of first load output off, controlling output mode of the second load, the time of first load output off, voltage of light control on, voltage of light control off, day or night instructions, battery power status, load status, as well as over voltage, low voltage, over load, short circuit, etc. Users can browse and set the parameters through the LCD key.

In addition, the controller has perfect protection functions, including: solar cells reverse charging, solar cells anti-reverse, battery over charge, battery over-discharge, battery anti-reverse, load short-circuit, overload, lightning, wind turbine current limiting, wind turbine automatic brake and manual brake.

The controller has intelligent and modularized design, simple structure, powerful function. The controller use high quality industrial components and excellent production activity, which make the controller is suitable for relatively poor working environment and has reliable performance and service life.

2. Model Description

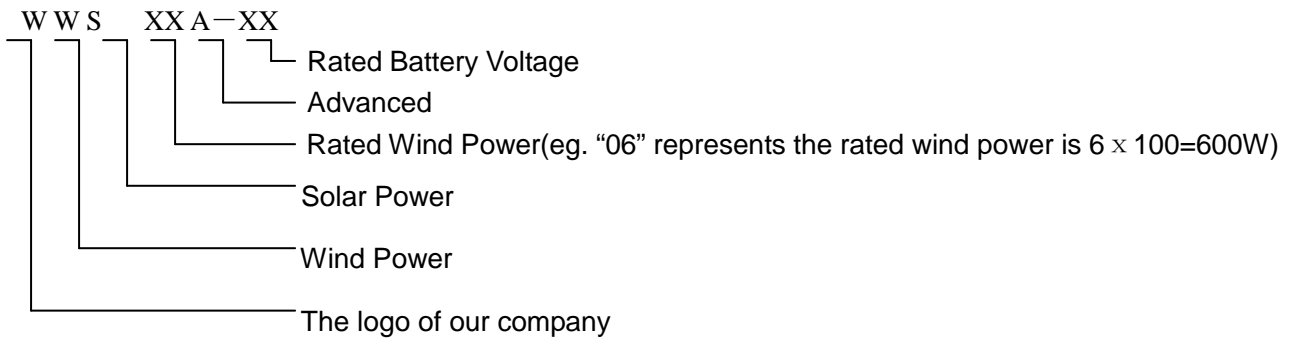

eg. WWS 03A-24 (300W Advanced Wind/Solar Hybrid Controller, Battery Voltage is 24V)

3. Features

- Intelligently and modularized design, simple structure, powerful function, stable performance.
- PWM charging with voltage limiting and current limiting, users can set the stop rotation speed of fan precisely.
- Two DC output, each DC output has seven selective modes of controlling load output : (1)constant on, (2)light-control on and light-control off, (3)light control on and time control off,
- TVS lightning protection
- Over-charging, over-discharge, short circuit by electronic device, overload protection and a unique anti-reverse protection
- Using the LCD professionally designed for wind/solar hybrid street light. The LCD can displays all system status and system parameters with intuitive digital and graph.
- Perfect protection function.

4. Operational Regulations

The wind&solar hybrid system connection diagram and the terminal hookup of advanced wind/solar hybrid controller is as follows:

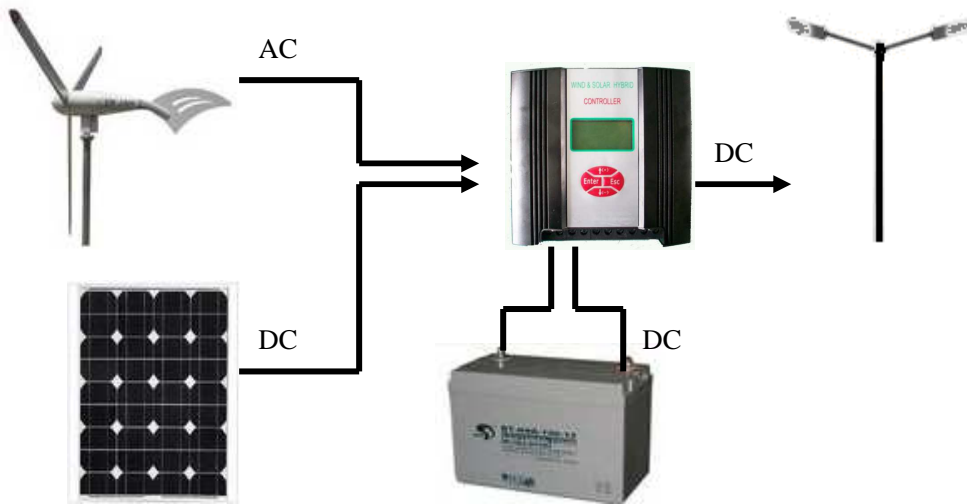

Picture 1, wind&solar hybrid system connection diagram

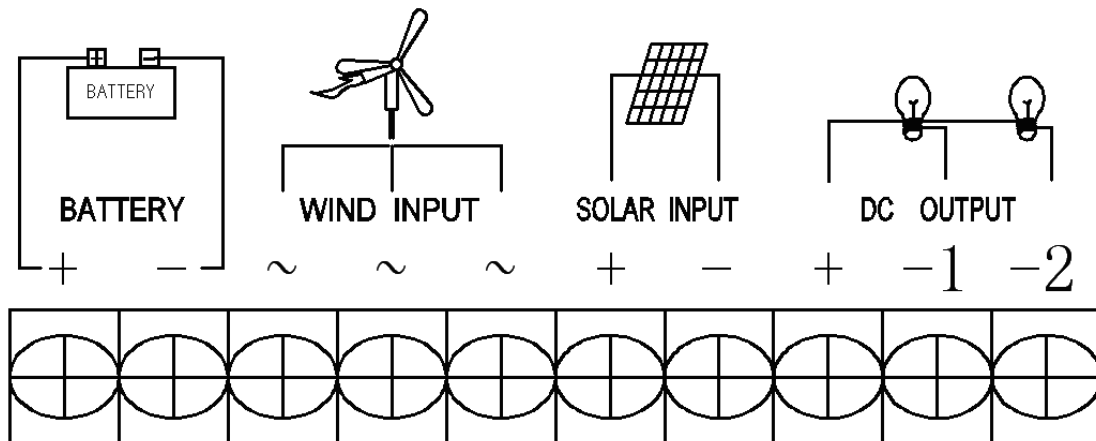

Picture 2, terminal hookup

After the wind/solar hybrid generating system is installed, please connect the controller accurately by the following order .

- Open the package and ensure whether the equipment is damaged due to transportation or not.
- Connect the DC load to “DC OUTPUT” terminal. One load should be connected to “+” and “-1” of the “DC OUTPUT” terminal and another load should be connected to “+” and “-2” of the “DC OUTPUT” terminal. The mode of load output can be setted according to the requirements of the load .The half-power output is only applicable to LED load.
- Connect the battery’s positive pole to the positive (+) of “BATTERY” terminal, and connect the

battery's negative pole to the negative(-) of "BATTERY" terminal with copper core cable(section surface $\geq 6\text{mm}^2$). Despite the controller has the battery reversed protection, but reversing battery is still forbidden!

- Make the wind turbine in brake status and then connect the output line of the wind turbine to the "WIND INPUT" terminal in back panel .
- Cover the solar panel with a shelter and the connect the solar panels to the "SOLAR INPUT" terminal in back panel.
- Remove the shelter of solar panle and release the brake switch of wind turbine.
- Users can set the parameters and the mode of load output by the control software and the key of LCD.

5. LCD operation and Display Instructions

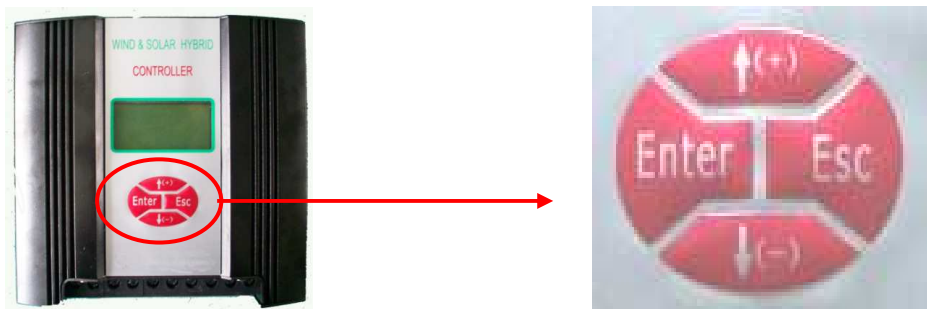

Picture 3, the key of LCD

5.1 Description of the Key:

Press any key, LCD backlight lights. The backlight will auto-off while stop pressing the key 10 seconds later.

- "↑(+)" key symbolizes increase or next one. In browsing window, press this key to display next parameter. In setting window, press this key to look the next parameter which can be modified or increase the value of the current parameter.
- "↓(-)" key symbolizes decrease or previous one. In browsing window, press this key to display the previous parameter. In setting window, press this key to look the previous parameter which can be modified or decrease the value of the current parameter.
- "Enter" key symbolizes set or confirm key. In browsing window, press this key to access setting









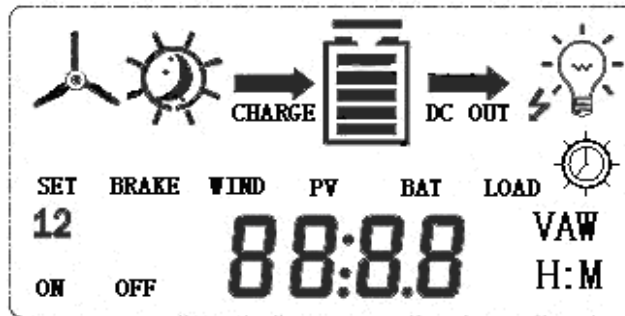





window. In setting window, press this key to save parameter and return to browsing window.

- "Esc" key symbolizes cancel or manual switch. In setting window, press this key to return to browsing window and do not save the modification. In browsing window, the key is as a manual reset key when the load short-circuit or overload occur.

5.2 Displaying Contents Description

LCD screen displays the following picture.



- 1)  symbolizes the wind turbine.
- 2)  symbolizes the day,  symbolizes the moon.
- 3)  symbolizes the battery, internal strip graph represents the status of battery power. When the battery is over-discharge, the symbol  flashing, this flashing will not stop until over-discharging's recovering ; When the battery is over-voltage, the symbol  flashing ,the flashing will not stop until over-voltage's recovering.
- 4)  symbolizes the status of load.
 - When normal loading without output displays  , normal loading with output displays  .
 - When overloading, the symbol  flashing, users must remove the extra load, click "Esc" key to recover the use of.
 - In short-circuit protection status, the symbol of short-circuit  flashing, users should check the load line, confirm the line is normal and press Esc key to recovery the use of manually.
- 5)  symbolizes light-control and time-control.  symbolizes light-controll open and light-control off.  symbolizes light control open and time control off.
- 6) The character "SET" symbolizes the setting status.
- 7) The character "12" symbolizes the first output and the second output.

8) **88:88** is parameters showing. The LCD can displays all system status and system parameters with intuitive digital and graph.

5.3 Browsing Parameters and Output Modes Description

1) Turn the power, the LCD displays browsing window and battery voltage: XX.X V;

2) In browsing window, LCD will circularly display the following parameters by pressing " $\uparrow(+)$ " key, battery voltage, wind turbine voltage, photoelectric voltage, wind power, PV power, wind turbine current, PV current, controlling output mode of the first load, the time of first load output off, controlling output mode of the second load, the time of first load output off, voltage of light control on, voltage of light control off. LCD will display parameters in reverse order by pressing " $\downarrow(-)$ " key.

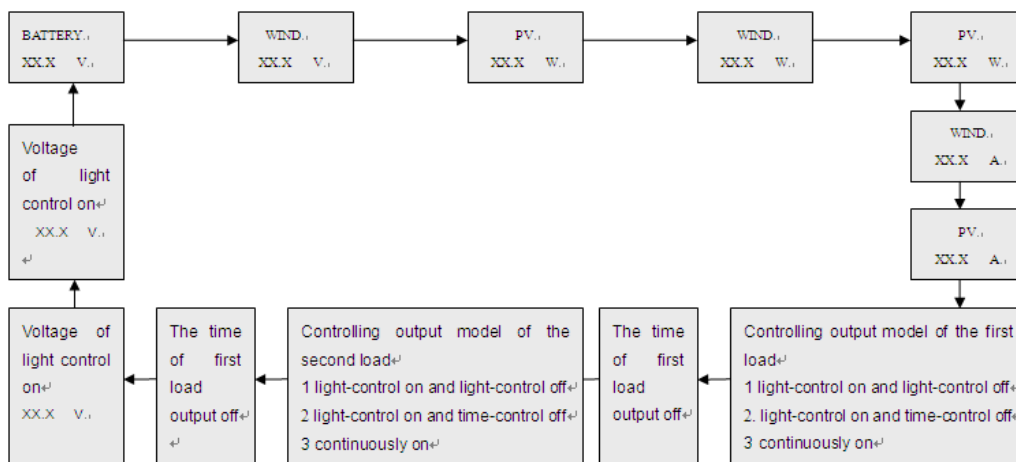

LCD can display three controlling mode of load output, including light control on and light control off, light control on and time control off, constant on.

The following are three controlling modes of the first output which are shown on the LCD.

1) See pictures below, light-control on and light-control off interface. Note: In order to show particularly the necessary content, we delete the top contents of the LCD.

Lower-left corner of LCD displays "1" which symbolizes the first output. The right side displays "load" and a sun symbol which suggest that the load is light control on and light control off. In this mode, the controller will detect the light intensity based on the solar cell voltage, start the corresponding load output automatically after dark and stop the output automatically at dawn. The voltage of light control on and light-control off can be set by LCD key and serial port.



light-control on and light-control off interface

2) See pictures below, light-control on and time-control off interface.

Lower-left corner of LCD displays "1" which symbolizes the first output. The right side displays "load" and a sun symbol which has a clock symbol. All this suggest that the load is light control on and time control off. In this mode, the controller will detect the light intensity based on the solar cell voltage, start the corresponding load output automatically after dark and stop load output automatically when the load is up to the time of time control off even though the time is not up to at dawn.



light control on and time control off interface

3) See pictures below, constant on interface.

Lower-left corner of LCD displays "1" which symbolizes the first output. The right side displays character "load" and lower-left corner displays character "on" symbolize the load is constant on, which means that the corresponding load has output within 24 hours except for low voltage protection status or fault condition. This mode is applicable to outdoor monitor system.



Constant on interface

5.4 Setting Parameters and Output Modes Description

The following parameters can be setted by LCD keys, the first load output mode, the second load output mode, the time of the first load off, the time of the second load off, the voltage of light control on and the voltage of light control off.

When users need to modify a given parameter, enter into setting window by pressing "Enter" key , and then view and modify parameters by pressing "↑(+)" or "↓(-)" key . After setting parameters, saving the modification and returning to browsing window by pressing "Enter" key, not saving the modification and returning to browsing window by pressing "Esc" key.

5.5 Manual Brake Setting:





Press the "Enter" key and "Esc" key simultaneously, LCD displays the symbol **BRAKE** that suggests fan is in brake status. Press the "Enter" key and "Esc" key simultaneously in brake status, the symbol

BRAKE will disappear and the brake status is released. In normal situation, the fan can not be setted in brake status.

6. Parameters

Model	WWS03A-12	WWS03A-24
Rated Battery Voltage	12V	24V
Rated Wind Turbine Maximum Power	300W	
Rated Wind Turbine Maximum Input Current;	40A	
Rated Wind Turbine Maximum Input Power	500W	
Unload Voltage (factory default)	14V	28V
Unload Current (factory default)	25A	
PV maximum Current	10A	
Battery over-discharge protection Voltage	11V	22V
Battery Over-discharge Recovery Voltage	12V	24V
Output Protection Voltage	16V	32V
Display Mode	LCD	
Display Parameters	Battery Voltage, Wind Turbine Voltage, PV Voltage, Wind Turbine Current, PV Current, Wind Turbine Power, PV Power.Ove-Voltage, Under-Voltage, Over-load, short circuit.Etc	
Range of working Temperature &Humidity	-20~+55°C/35~85%RH (Without Condensation)	

7. Abnormal phenomenon and treatment

Phenomenon	Description
The symbol  flashing, without charge or discharge	Battery is over-voltage, check battery voltage, and the cable is connected or not, reconnect all components;
The symbol  flashing and no output	Battery is over-discharging and battery is empty. Please continue to use the battery after charging the battery. Remove the battery and recover it with battery-charging device if the battery is over discharging for a long time.
The symbol  flashing and no output	Over loading occurring. Please check the load and ensure that the load power consumption is not exceed the rated current of product, remove the excess or abnormal load, press "Esc" key to recover the use of.
The symbol  flashing and no output	Short-circuit protection occurs. Please check the load and connecting wire, remove the short-circuit risks or damaged load, press "Esc" key to recover the use of.

If the phenomenon do not meet the description or can not return to normal, please contact our service department or salesman to repair or replace.

8. Warranty and after Sales Service

We provided product to the warranty period of one year since it is sold.

If the product is exceed warranty or damaged by transportation, improper use, human element, force majeure, it is not under warranty.

Declare: The product has applied for patent protection, counterfeiting will be subject to legal sanctions. Our Company reserves the right to change products and without notice when products update.